

EP 5560-GP

**EP 5560**  
 Bike rack, 6 bikes capacity  
 Frame made of hot dipped galvanized steel.  
 URBANITI Collection page 4.

OPTIONS	WEIGHT	CONCRETE SLAB	ANCHORS
GP – Galvanized and painted frame	115 lbs	7009	QS (4) or QAV (4)

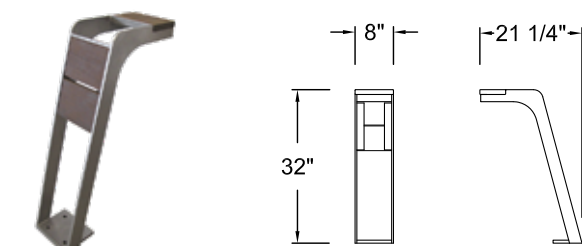

EP 5630-IPE-P

**EP 5630**  
 Bike rack, 2 bikes capacity  
 Frame made of steel with a zinc rich primer, painted.  
 PLAZA Collection page 16.

COVERINGS	WEIGHT	CONCRETE SLAB	ANCHORS
Wood: IPE, JAT or HWA	55 lbs	7005	QS (4) or QAV (4)



**EP 5690**  
 Bike rack, 2 bikes capacity  
 Frame made of hot dipped galvanized steel tubing covered with 2 cast aluminum panels, painted.  
 Ring made of steel tubing with a black paint.  
 Inground mount.  
 Also available with a surface mount.  
 INTERNATIONALE Collection page 24.



OPTION	WEIGHT	CONCRETE SLAB	ANCHORS
LOGO – Add your logo	75 lbs	7005	QS (4) or QAV (4)

**EP 5790**  
 Bike rack, 2 bikes capacity  
 Frame made of aluminum, painted.  
 MTL Collection page 6.

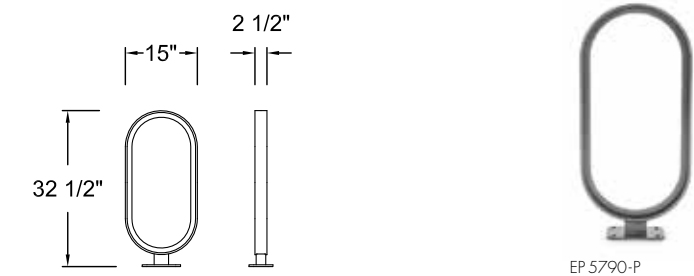

WEIGHT	CONCRETE SLAB	ANCHORS
15 lbs	7005	QS (4) or QAV (4)



EP 5900-P

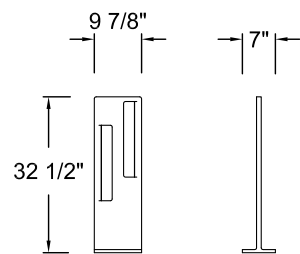

**EP 5900**  
 Bike rack, 2 bikes capacity  
 Frame made of aluminum, painted.  
 PROMENADE Collection page 20.

WEIGHT	CONCRETE SLAB	ANCHORS
35 lbs	7005	QS (4) or QAV (4)

**EP 5903**  
 Bike rack, 6 bikes capacity

Frame made of hot dipped galvanized steel tubulars, all welded.

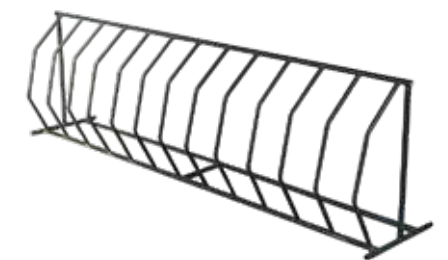
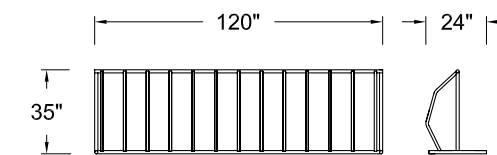

EP 5903-GP

OPTION	WEIGHT	CONCRETE SLABS	ANCHORS
GP – Galvanized and painted frame	100 lbs	7028 (2)	QS (4) or QAV (4)

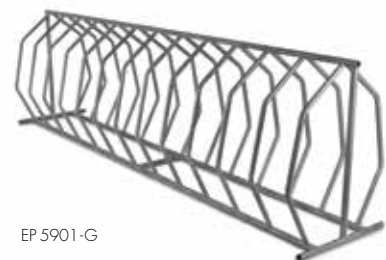

EP 5901-G

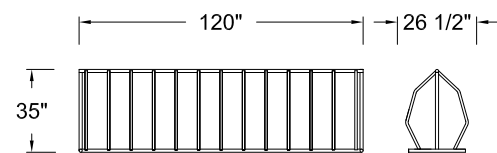

**EP 5901**  
 Bike rack, 12 bikes capacity  
 Frame made of hot dipped galvanized steel tubulars, all welded.

OPTION	WEIGHT	CONCRETE SLABS	ANCHORS
GP – Galvanized and painted frame	160 lbs	7028 (2)	QS (4) or QAV (4)

**EP 5910**  
 Bike rack, 2 bikes capacity

Frame made of brushed stainless steel.

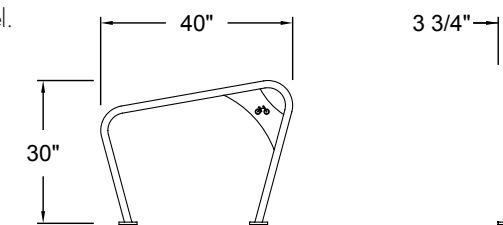

EP 5910

WEIGHT	CONCRETE SLABS	ANCHORS
22 lbs	7009 (1)	QS (4) or QAV (4)

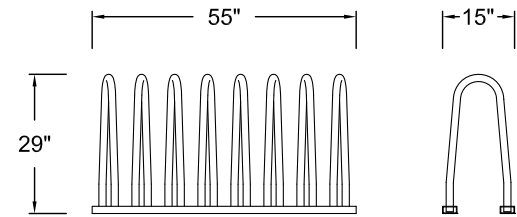

**EP 5911**  
Bike rack, 7 bikes capacity  
Frame made of hot dipped galvanized steel tubulars, all welded.

EP 5911-7-GP

OPTION	WEIGHT	CONCRETE SLABS	ANCHORS
GP – Galvanized and painted frame	70 lbs	7009 ou 7028 (2)	QS (4) or QAV (4)

**EP 5920**  
Bike rack, 2 bikes capacity

Frame made of aluminum, painted.  
Lateral protections made with black rubber, molded by compression.  
Collection 25 page 22.

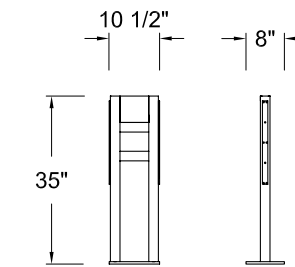

EP 5920-IPE-P

COVERINGS	WEIGHT	CONCRETE SLAB	ANCHORS
Wood: DFP, IPE, JAT or HWA	20 lbs	7005	QS (4) or QAV (4)
Recycled plastic: CRPU, ORPU, SRPU, WRPU or YRPU			

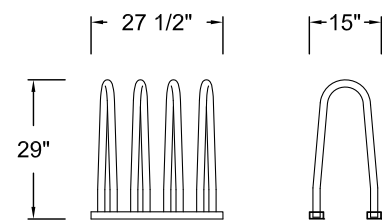

**EP 5911-3**  
Bike rack, 3 bikes capacity  
Frame made of hot dipped galvanized steel tubulars, all welded.

EP 5911-3-G

OPTION	WEIGHT	CONCRETE SLABS	ANCHORS
GP – Galvanized and painted frame	40 lbs	7003 or 7028 (2)	QS (4) or QAV (4)

**EP 5930**  
Bike rack, 5 bikes capacity

DIMANCHE Collection page 14.

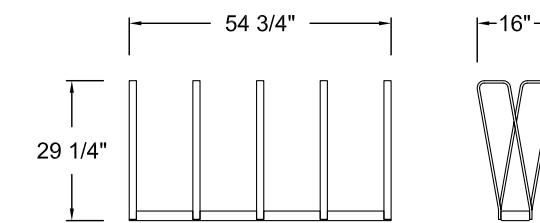

EP 5930-GP

OPTION	WEIGHT	CONCRETE SLABS	ANCHORS
GP – Galvanized and painted frame	110 lbs	7009 or 7028 (2)	QS (4) or QAV (4)

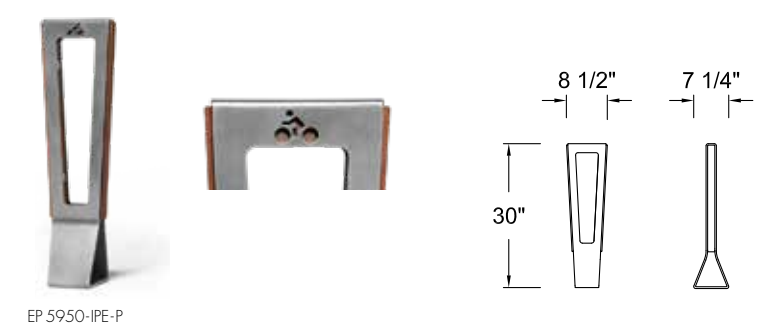

EP 5950-IPE-P

**EP 5950**  
 Bike rack, 2 bikes capacity  
 Frame made of hot dipped galvanized steel, painted.  
 Bicycle pictogram included.  
 DELTA Collection page 12.

COVERINGS	WEIGHT	CONCRETE SLAB	ANCHORS
Wood: IPE, JAT or HWA	30 lbs	7005	QS (4) or QAV (4)

**EP 5980**  
 Bike rack, 2 bikes capacity  
 Frame made of aluminum, painted.  
 Bicycle pictogram included.  
 \*Also available with LED technology.  
 TANGO Collection page 10.



EP 5980  
 (40 lbs)

EP 5980-P

CONCRETE SLABS	ANCHORS
7005 or 7016	QS (2) or QAV (2)

\*LED technology available at Lumca exclusively. 1 877 650-1693

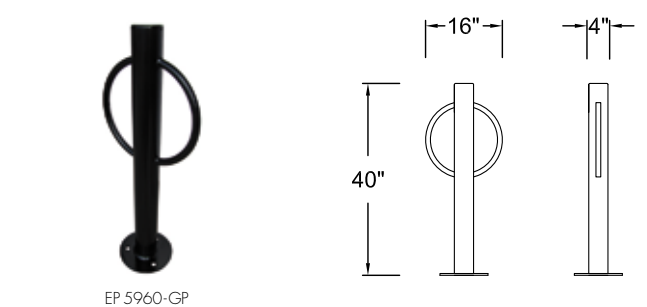

EP 5960-GP

**EP 5960**  
 Bike rack, 2 bikes capacity  
 Hot dipped galvanized tubular steel frame, all welded.

OPTION	WEIGHT	CONCRETE SLABS	ANCHORS
GP – Galvanized and painted frame	40 lbs	7005 or 7016	QS (3) or QAV (3)

**EP 5990**  
 Bike rack, 2 bikes capacity  
 Frame made of aluminum, painted.  
 The inground mount version allows to remove the frame for storage.  
 Also available with a surface mount.  
 ESPLANADE Collection page 18.

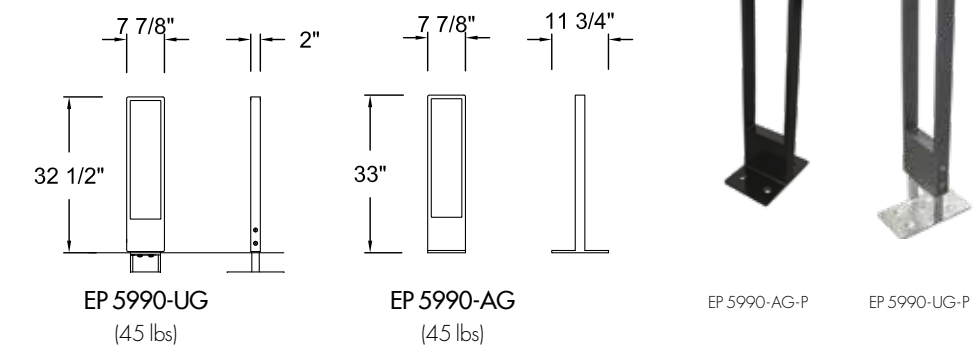

EP 5990-UG  
 (45 lbs)

EP 5990-AG  
 (45 lbs)

EP 5990-AG-P

EP 5990-UG-P

OPTIONS	CONCRETE SLAB	ANCHORS
AG – Surface mount	7005	QS (4) or QAV (4)
UG – Inground mount		